

Brouwer

Sinds 1922
MEUBELN

bank

Molde



In vele kleuren & materialen leverbaar



In vele afmetingen & opstellingen mogelijk



Keuze uit diverse pootjes (ook in hoogte)



Verkrijgbaar met relaxfunctie ⚙️



ACCU voor relaxfunctie (geen snoer nodig)



Bijpassende hocker(s) & armkussens

PRIJZEN OP AANVRAAG

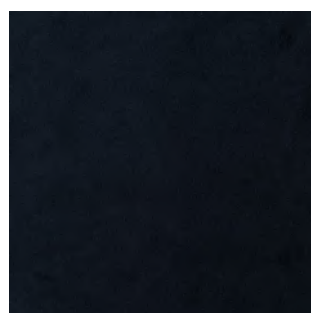

Versailles (2) - Dark Blue



Adore (2) - Gold

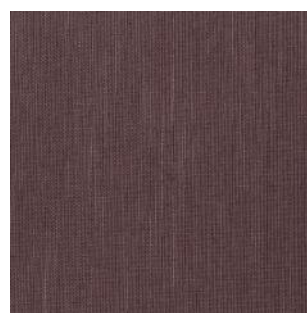

Mood (1) - Aubergine

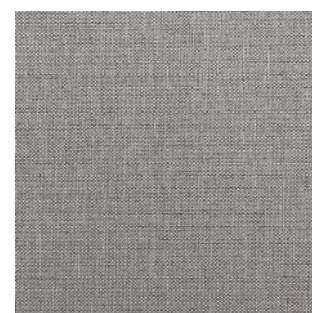

Beach (1) - Sand

In showroom

en nog is 200 opties!

Opstellingen & afmetingen

Aan de hand van de onderstaande elementen kun u uw ideale opstelling samenstellen. De elementen bestaan uit verschillende zitbreedtes.

Let op: Bij gebruik van een  relaxfunctie zult u altijd met de 1 zits (Cxx) moeten werken.

Aangegeven afmetingen kunnen afwijken i.v.m. stoffering hou **CA. 1 cm per element aan.**

Alle elementen (met uitzondering de chaise longue) zijn exclusief armleuningen. Deze dienen erbij opgeteld te worden.

Opties

	Relaxfunctie met touch sensors (0-wall - Bank kan dicht bij de muur staan)
	Accu voor relaxfunctie (geen snoer nodig - opladen 6 uur)
	Verstelbare hoofdsteun (In dezelfde style als het meubel - 5 maten)

1 zit
(zonder armen)

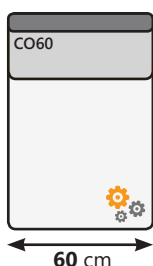

2 zit
(zonder armen)

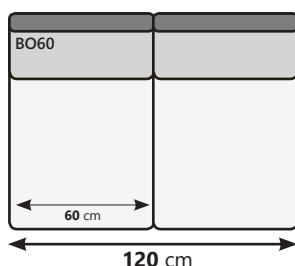

Armlegger Molde
(B 14 cm - H 66 cm)

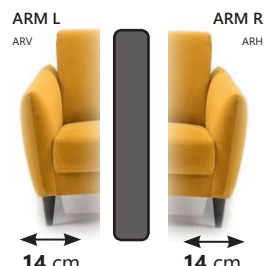

1,5 zit
(zonder armen)



2,5 zit
(zonder armen)

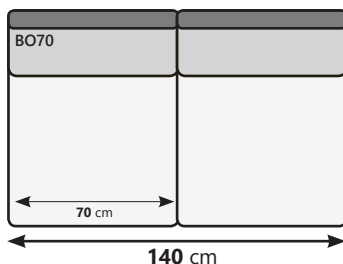

1,5 zit
(zonder armen)

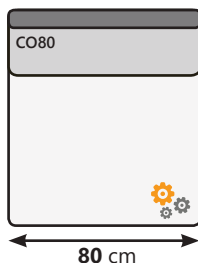

2,5 zit
(zonder armen)

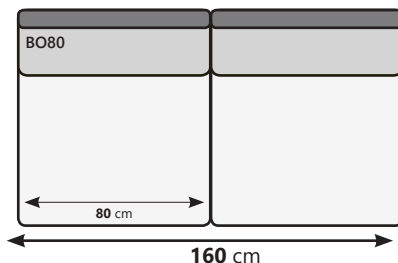

1,5 zit
(zonder armen)



3 zit
(zonder armen - met 2 zitkussens)

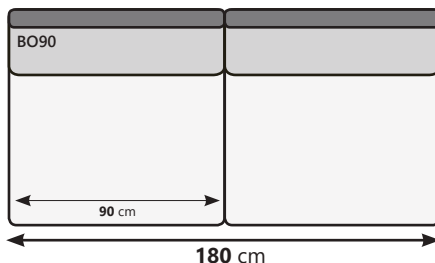

3 zit
(zonder armen - met 3 zitkussens)

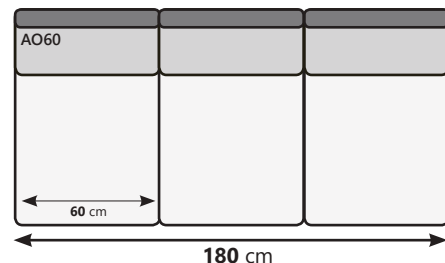

bank **Molde**



Hoek
(recht)

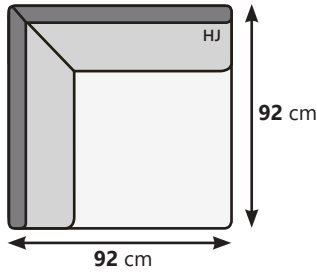

Hoek
(schuin)

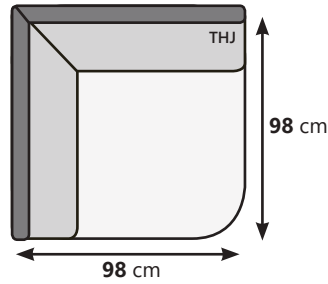

Ottomane Rechts
(hoek met open einde)

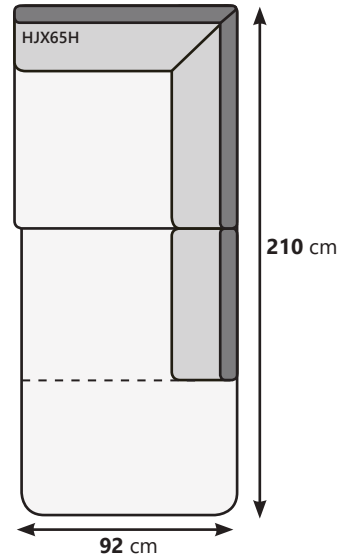

Ottomane Links
(hoek met open einde)

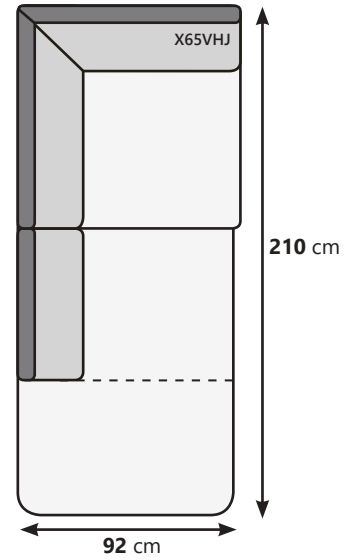

1 zit met hocker Rechts

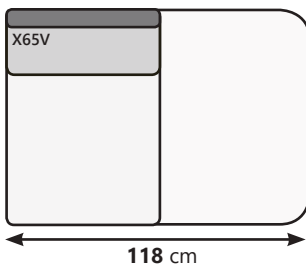

1 zit met hocker Links

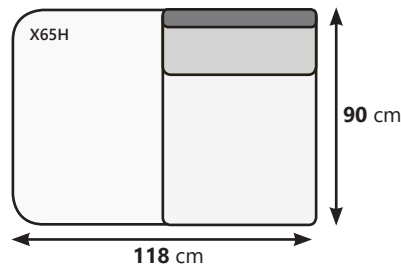

Chaise longue S
(met arm Links)

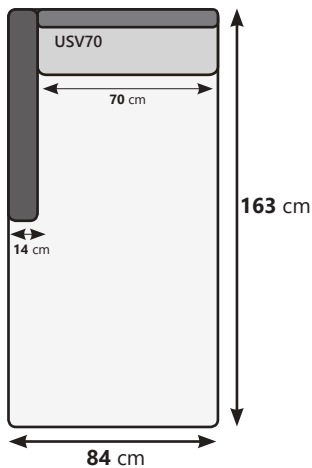

Chaise longue S
(met arm Rechts)

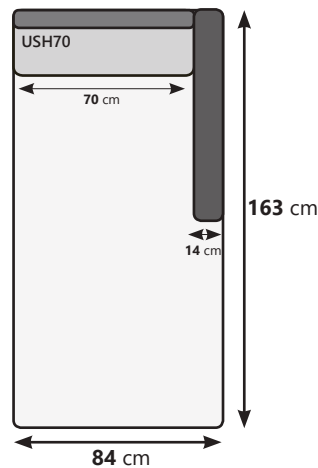

Chaise longue XL
(met arm Links)

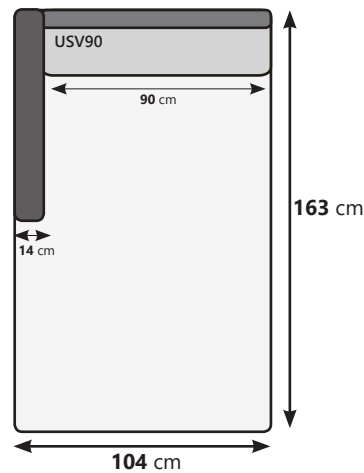

Chaise longue XL
(met arm Rechts)

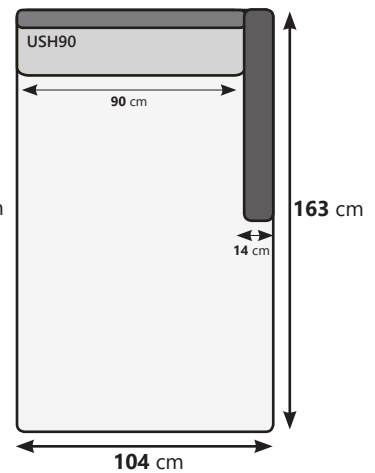

Hockers (los)



De hocker en de hoofdsteun zijn altijd in dezelfde style als de bank.

Hocker 60x60

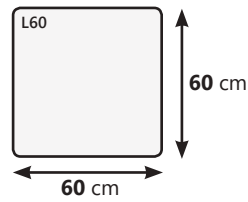

Hocker 70x60

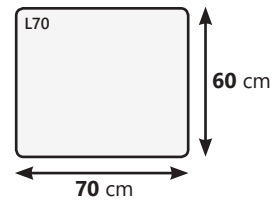

Hocker 80x60

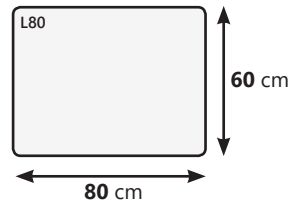

Hocker 90x60

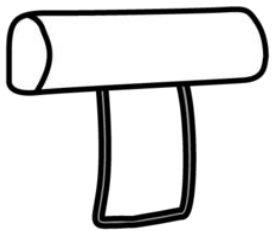
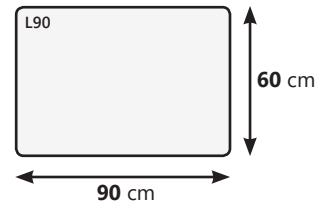

Hoofdsteunen (verstelbaar)

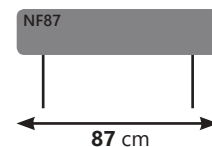
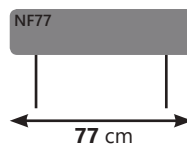
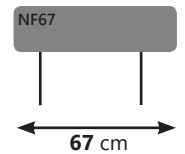
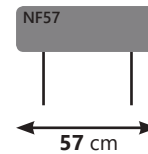
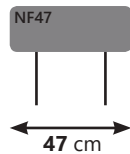

Indien gekozen wordt voor een  relaxfunctie is een verstelbare hoofdsteun (NF) voor extra comfort nodig! (Handmatig)

Wij adviseren om deze toe te voegen.

PRIJZEN OP AANVRAAG

Poot mogelijkheden 16 cm = standaard

200 mm	Type 0F7 20 cm	Type 0H9 20 cm	Type 0I4 20 cm	Type 1H7 20 cm	Type 2G9 20 cm	Type 2H3 20 cm	
							
160 mm	Type 098 16 cm	Type 046 16 cm	Type 0I5 16 cm	Type 1A6 16 cm	Type 2H1 16 cm	Type 2H4 16 cm	Type 2M1 16 cm
							
105 mm	Type 0E1 10,5 cm	Type 0I1 10,5 cm	Type 0I5 10,5 cm	Type 1H8 10,5 cm	Type 2H6 10,5 cm	Type 2H5 10,5 cm	
							
Diverse hout kleuren mogelijk.	JA	x	JA	x	JA	x	MEERPRIJS

Hout kleur opties:

- Beuken gelakt
- Beuken onbehandeld
- Eiken onbehandeld
- Eiken gelakt
- Eiken geolied
- Beuken zwart
- Eiken wit geolied
- Beuken donkerbruin
- Beuken bruin
- Beuken noten gelakt



PRIJZEN OP AANVRAAG

Voorbeelden

Let op: Dit zijn verschillende banken! Afmetingen, armleggers & opties kunnen verschillen.

Bank **Fjone**

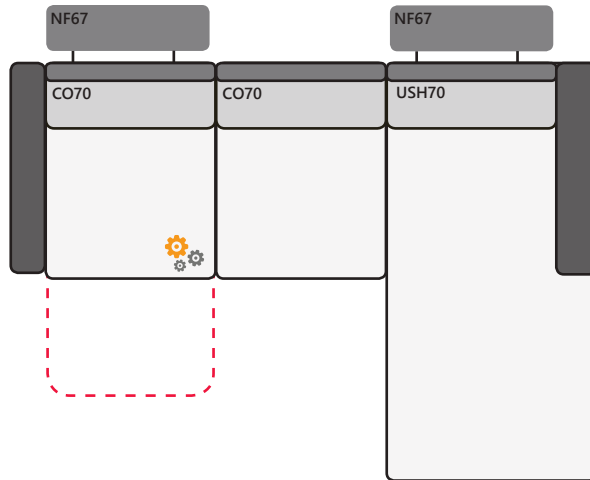
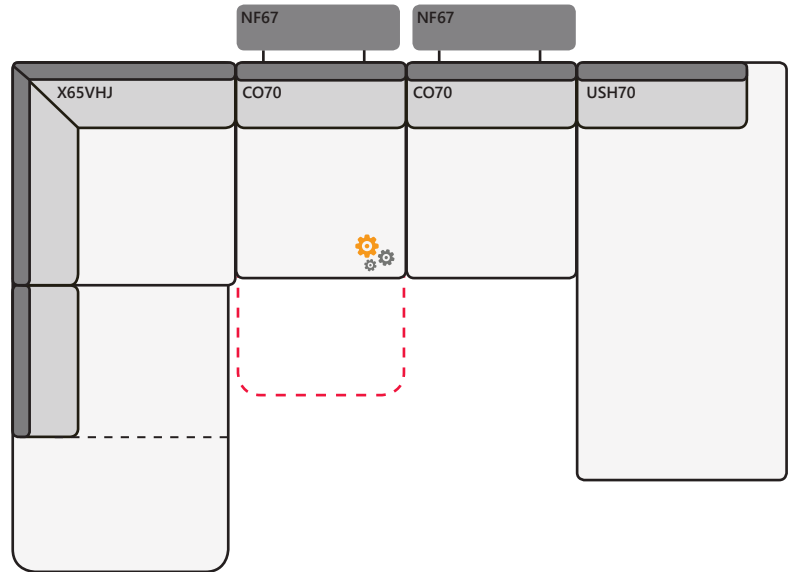

Bank **Ribe**

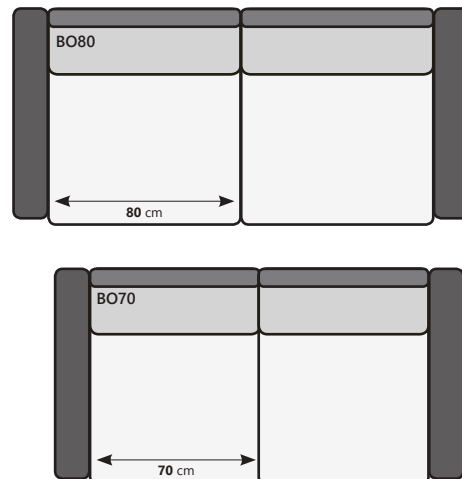

Bank Ribe

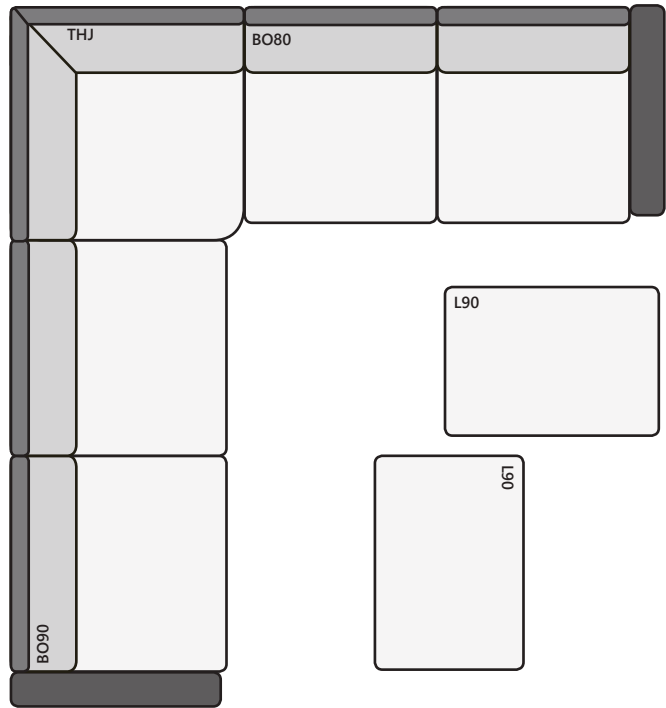

Bank Fjone

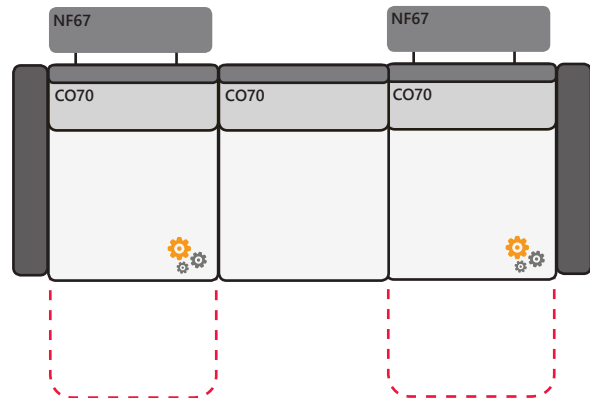

Loveseat Felle

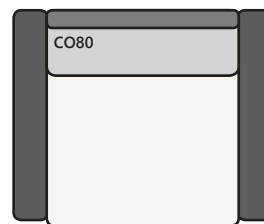

 G. Rietveldweg 3
Heerhugowaard

 072 – 5741160

 info@brouwermeubelen.nl

 brouwermeubelen.nl

 **Openingstijden**

Maandag
Dinsdag
Woensdag
Donderdag
Vrijdag
Zaterdag
Zondag

12:00 uur – 17:30 uur
09:00 uur – 17:30 uur
09:00 uur – 17:30 uur
09:00 uur – 17:30 uur
09:00 uur – 17:30 uur
10:00 uur – 17:00 uur
Gesloten