

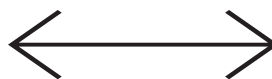

bank **Els**

**Diverse opstellingen
en afmetingen
mogelijk.**

(Ook als hoekbank)



In vele **kleuren stof**
verkrijgbaar.



**Diverse poot
mogelijkheden.**



Met bijpassende **hocker**
en **armkussens** leverbaar.





bank **Els**

Opstellingen & afmetingen

Afzonderlijke elementen

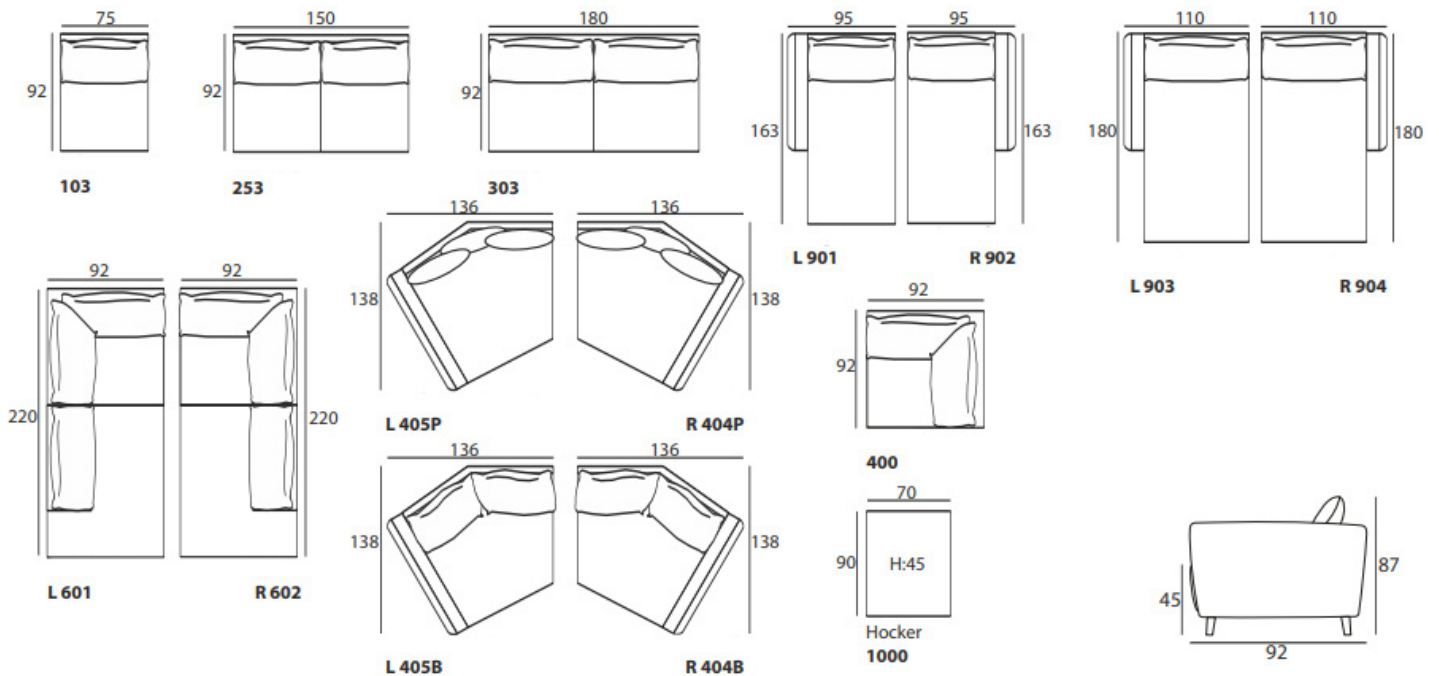

Bevestigings elementen

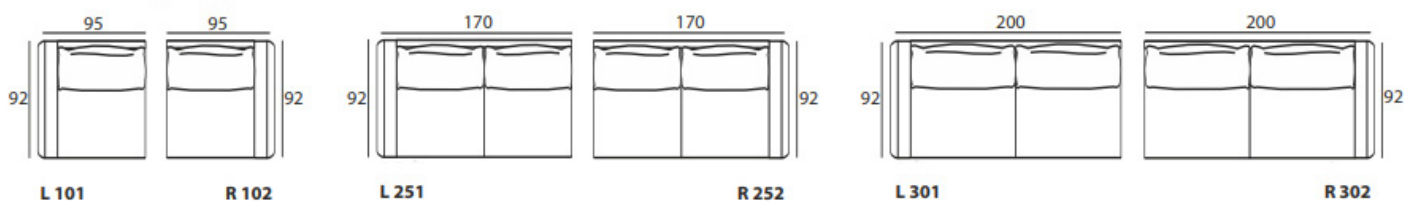



Brouwer

Sinds 1922
MEUBELN

bank **Els**

Standaard banken

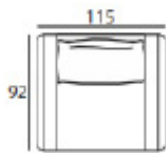

100

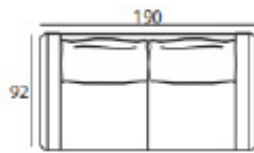

250



300

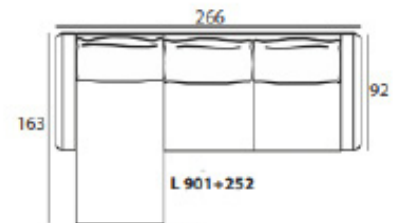

L 901+252

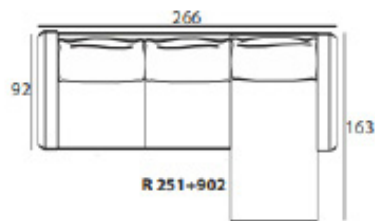

R 251+902

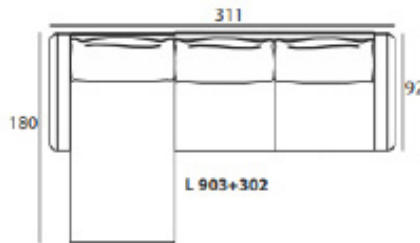

L 903+302

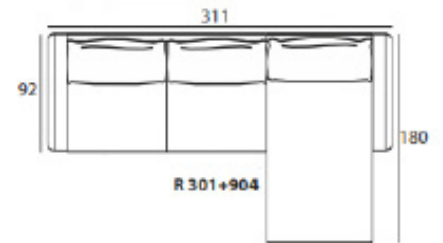

R 301+904

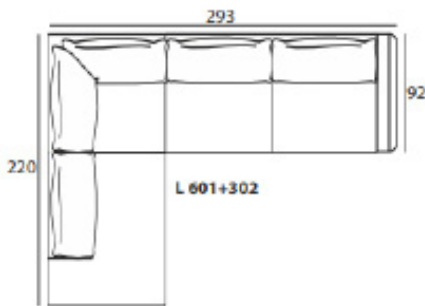

L 601+302

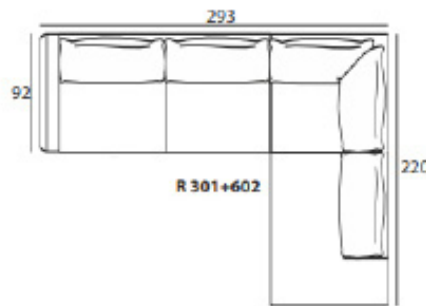

R 301+602

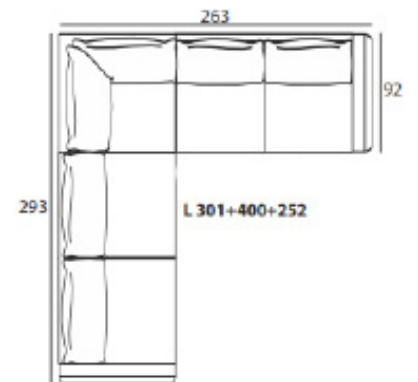

L 301+400+252

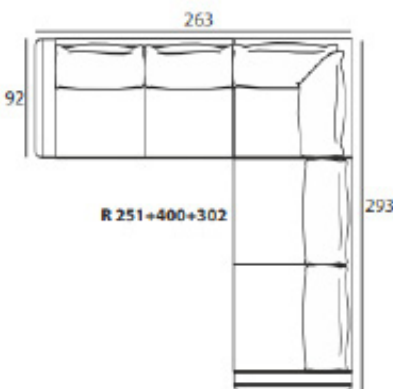

R 251+400+302



901+253+902

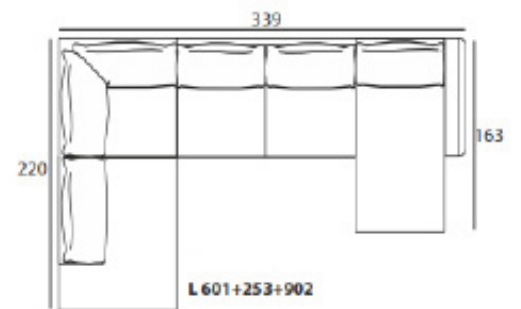

L 601+253+902

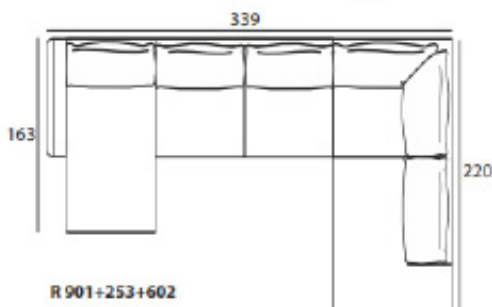

R 901+253+602

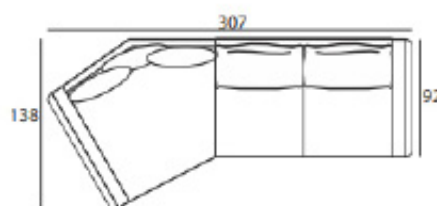

L 405P + 252

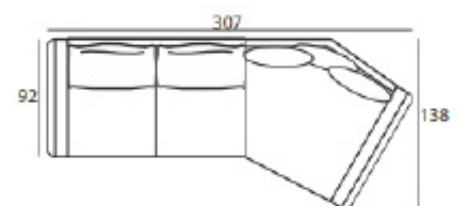

R 251 + 404P

bank

Els



Poot mogelijkheden.

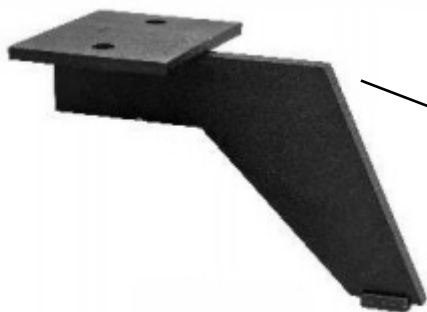

zwart metalen poten



Houten poten
blank, geolied, zwart

